

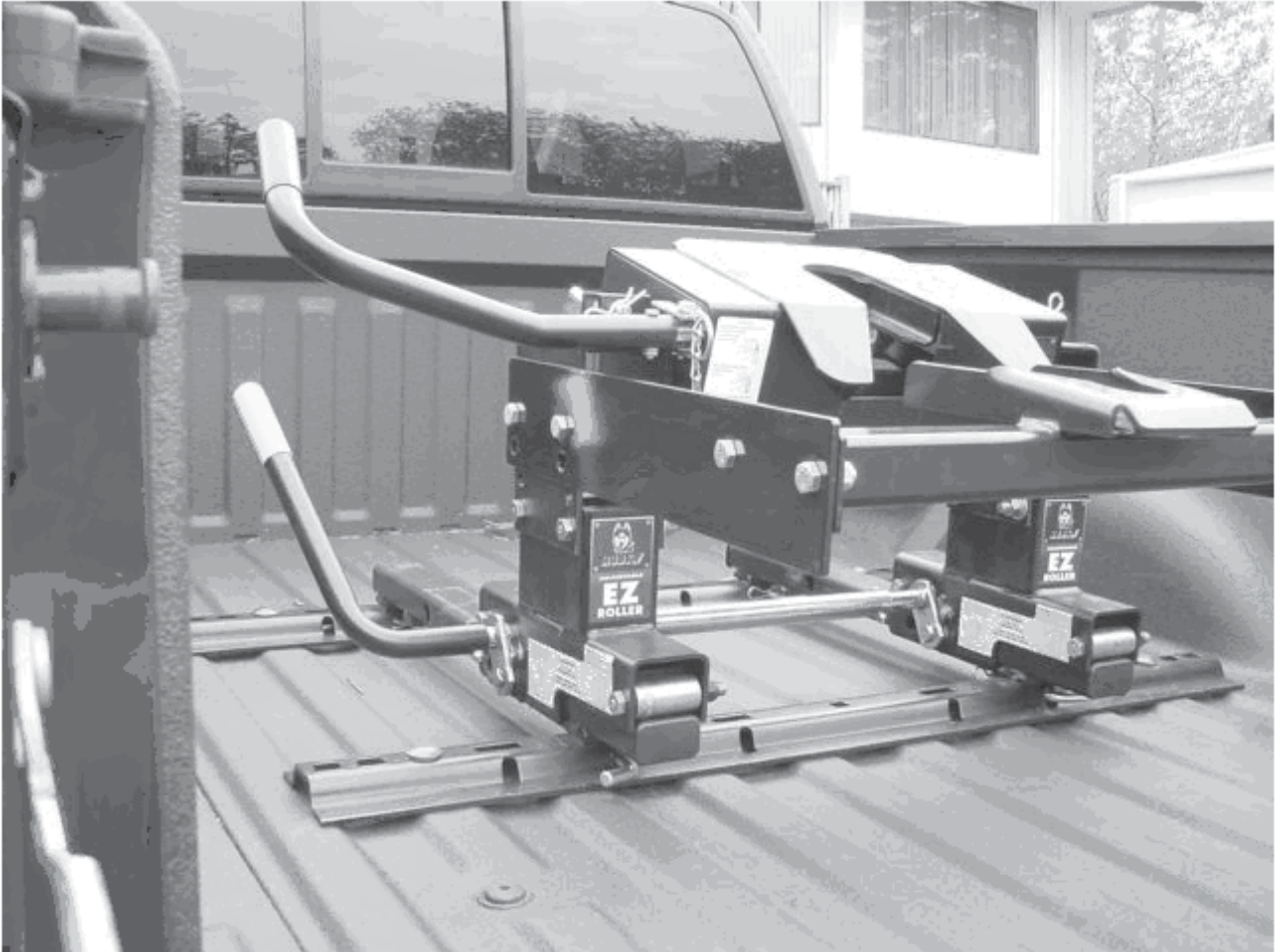

Strong As An Ox™

BedSaver™

Serial No.



Operator and Installation Manual BXR4401 BEDSAVER-HUSKY/VALLEY 15K

Unless otherwise specified, the bedsaver will
NOT work with aftermarket pin boxes. See fit list.

TO BE VALID, THE WARRANTY CARD MUST BE COMPLETED IN ITS ENTIRETY BY AN AUTHORIZED
DISTRIBUTOR OR DEALER AND SENT TO AUTOMATIC EQUIPMENT MFG. CO., PENDER,
NEBRASKA OR REGISTERED ONLINE AT www.blueox.us.
FAILURE TO DO SO WILL VOID THE WARRANTY.



Strong As An Ox™

Safety Information

SPECIAL DANGER MESSAGE

The act of uncoupling your fifth wheel trailer from your tow vehicle is, singularly, the most dangerous act to be performed when RVing. Many accidents have occurred where broken bones, severed limbs and even death by crushing have resulted from inadvertently dropping the fifth wheel trailer when a person has placed part of his/her body between the tow vehicle and the frame of the fifth wheel trailer. All of these accidents are completely avoidable by following a few simple rules, even without installing BedSaver™ on your hitch.

- Chock your trailer wheels.
- Extend your front jacks until you see no weight is on the hitch.
- NEVER place any part of your body between the trailer frame and tow vehicle or hitch.
- NEVER allow any helper or observer to place any body part between the trailer frame and tow vehicle or hitch.

BedSaver™ prevents damage to your tow vehicle™ when an inadvertent release happens. BedSaver™ may NOT prevent injury to someone violating the simple rules above.

For everyone's good, and for a safe and happy RVing experience, follow the above rules and NEVER COMPROMISE them.

Safety Information

- 1) Blue Ox™ strongly recommends dealer installation and/or by a certified technician.
- 2) DO NOT ATTEMPT TO INSTALL THIS PRODUCT WITHOUT FIRST READING THESE INSTRUCTIONS.
- 3) WARNING! FAILURE TO INSTALL THIS PRODUCT PROPERLY CAN RESULT IN DAMAGE TO YOUR FIFTH WHEEL TRAILER, TOW VEHICLE, FIFTH WHEEL HITCH AND/OR CAUSE BODILY INJURY.
- 4) This product is not designed or intended for use with fifth wheel trailers having a pin weight of 4000 pounds or more.
- 5) Your BedSaver™ should be inspected for damage after each incident. Note: An incident is defined as any time BedSaver™ catches your trailer.

Special Messages

“NOTE” provides enhancement information pertinent to the specific step of the procedure being undertaken.

“CAUTION” indicates a potential hazard exists that could result in damage to the tow vehicle, fifth wheel trailer or the fifth wheel hitch.

“WARNING” indicates a potential hazard exists that could result in personal injury, or death

Assumptions

It is assumed that you have the Husky-15 & 16K hitch installed properly. If not, have your hitch installed by a certified technician.



Strong As An Ox™

Parts List

Inspect the parts in your kit and check them off against the pictures and parts list below.

<u>Qty</u>	<u>Description</u>	<u>Picture #</u>
1	Cross tube Weldment	1
2	Side plate	2
8	Bolt, 1/2"-13 X 1 1/4", Zinc Plated	3
8	Lock Nut, Nylock, 1/2"-13, Zinc Plated	4

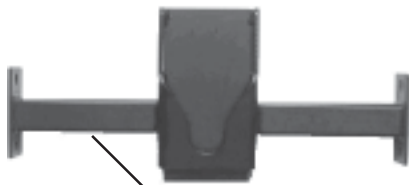

Picture 1

Location of Serial & Model #'s



Picture 2



Picture 3



Picture 4

If any of these parts are missing refer to page 6 for part numbers then, call a Blue Ox™ dealer or the factory.

Tools Required

3/4" Socket

3/8" Drive Ratchet

3/4" Comb. Wrench

Torque Wrench

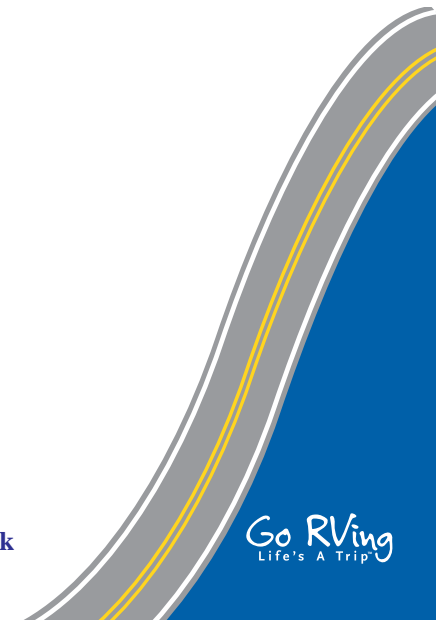



Strong As An Ox™

Installation

Requirements for placement of BedSaver™ Side Plates

The BedSaver™ Side Plates are mounted with the beveled corners located on the bottom and toward the rear of the tow vehicle.

Note: You will find a label on each Side Plate. The labels should be placed to the outside of the hitch.

Step 1

Referring to **Figure 1 & 2** below and using two of the bolts and Nylok lock nuts supplied with the kit, position the Left Side Plate onto left hitch vertical support such that the top hole pairs of the Side Plate align with the top pair of bolt holes in the left hitch vertical support. Insert the two bolts with the shanks inward and install two nuts. Do not tighten the nuts.

Step 2

Repeat **Step 1** for the right side plate

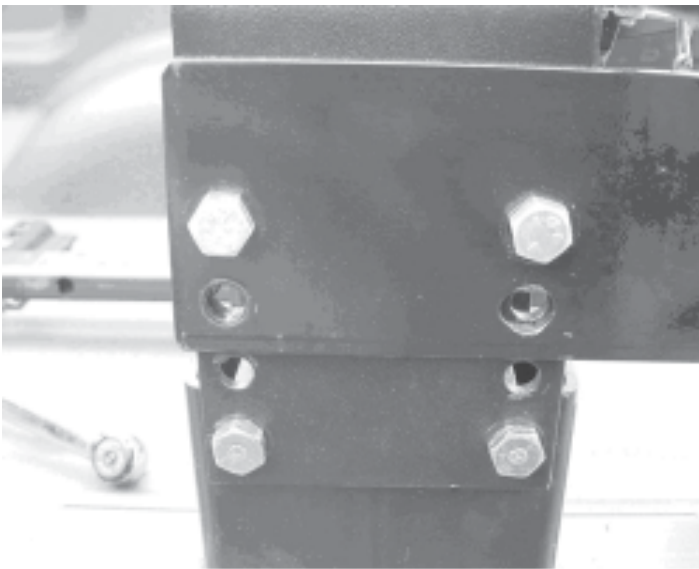

Figure 1- Side Plate Placement

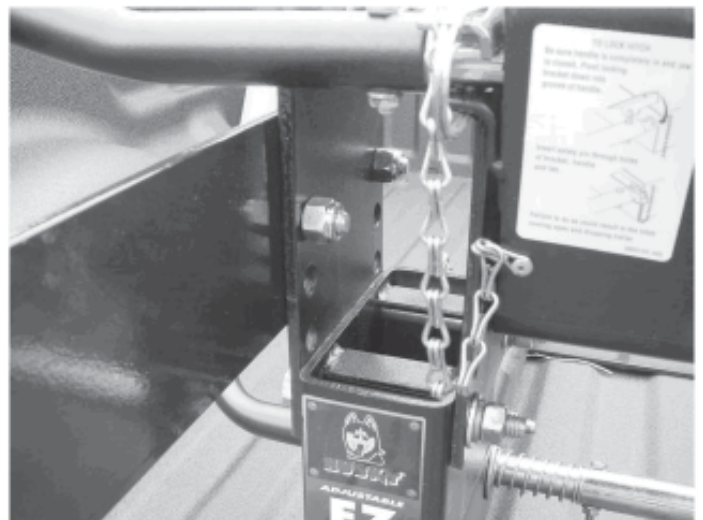

Figure 2- Side Plate Installed



Strong As An Ox™

Cross Tube Installation

Step 3

Refer to **Figure 3**, below for details. Using the remaining four bolts and Nylok nuts supplied with the kit, attach the Cross tube Weldment to the left and right Side Plates. Insert the bolts with the heads on the outside and finger tighten the nuts.

Step 4

Inspect the Side Plates and Cross tube for proper placement, refer to **Figure 4**. When satisfied that it appears correct, tighten the eight nuts securing the Side Plates to the hitch frame, then tighten the four nuts and bolts attaching the Cross tube to the Side Plates. **Torque all nuts to 65 foot-pounds.**

NOTE: When tightening the Side Plates to the hitch frame sides, it may be necessary to lift the Side Plate for proper alignment and leveling.

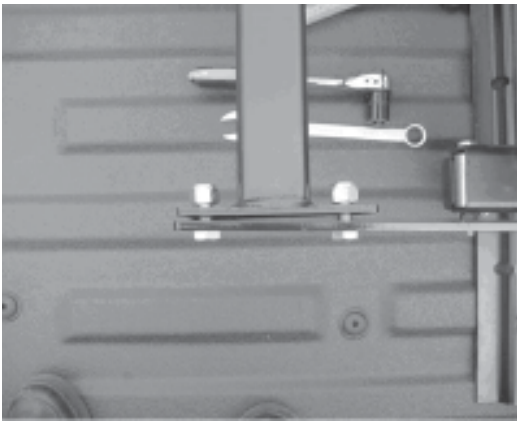

Figure 3-Cross Tube Attachment



Figure 4-Alignment



Figure 5-Complete Installation, Rear

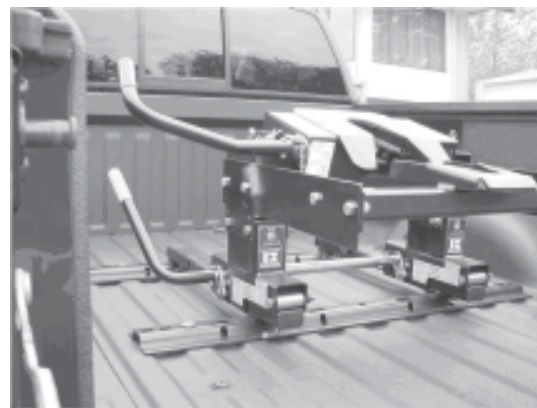

Figure 6-Complete Installation

Step 5

Inspect your work and check to be certain all nuts and bolts have been properly tightened. A sample installation is shown in **Figures 5 & 6**.



Strong As An Ox™

Parts List

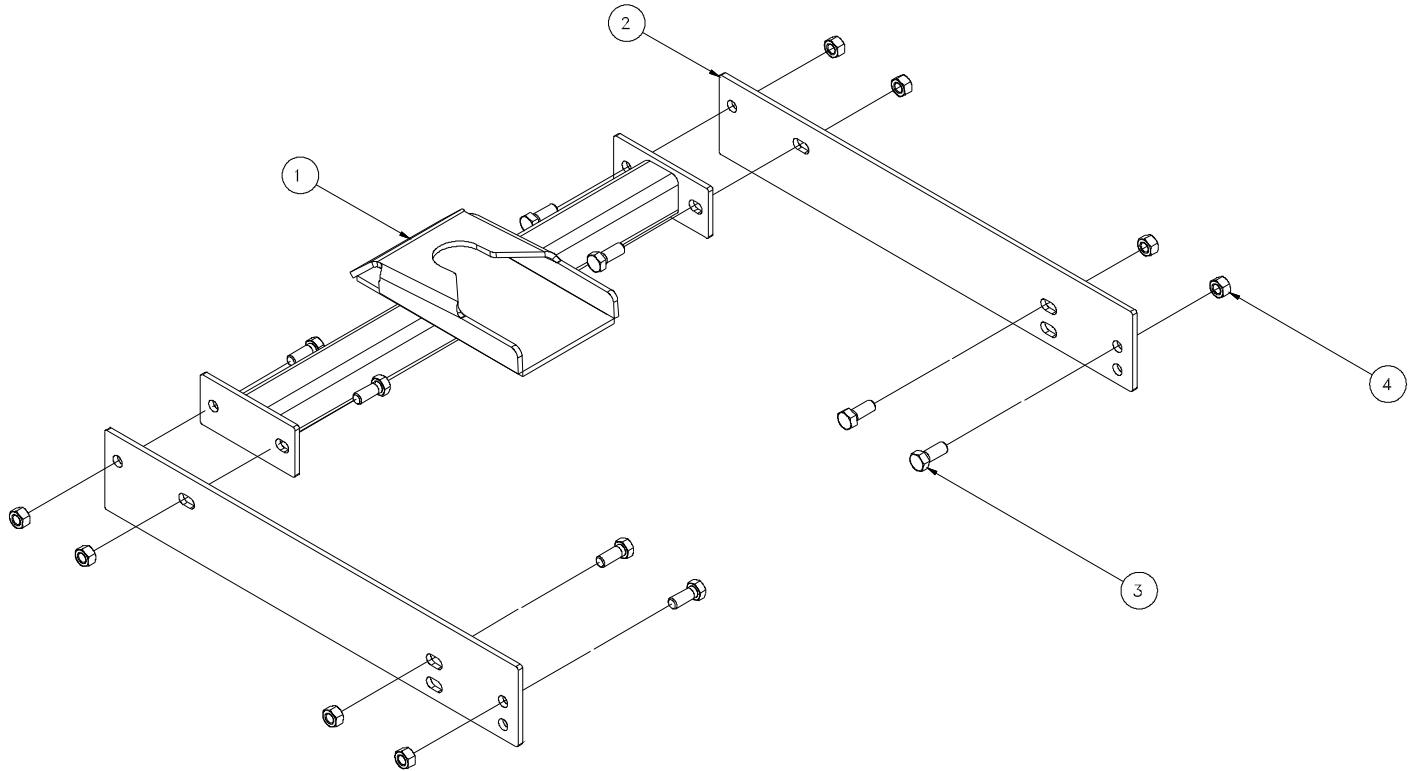

Parts List

Ref. No.	Qty.	Part No.	Description
1	1	61-6110	WLDMT, BEDSAVER X-TUBE, 24 1/4
2	2	101-6767	PLATE, BEDSAVER SIDEPLATE, BXR4401
3	8	201-0776	1/2-13 X 1 1/4 HEX BOLT, GRD. 8
4	8	202-0094	1/2-13 HEX NYL. INS. LOCK NUT, ZP

IMPORTANT: Use only genuine factory replacement parts on your bracket kit. Do not substitute homemade or nontypical parts. If a bolt is lost or in need of replacement, for your safety and the preservation of your bracket kit, be sure to use a replacement bolt of the same grade. Repair parts may be ordered through your nearest **Blue Ox™** dealer or distributor.